

The City of Durant encourages participation from all its citizens. If participation at any public meeting is not possible due to a disability, notification to the City Clerk at least 48 hours prior to the scheduled meeting is encouraged in order to make the necessary accommodations. The City of Durant may waive the 48-hour rule if interpreters for the deaf (signing) or translation services for limited English proficient (LEP) individuals are not the necessary accommodation.

**DURANT COMMUNITY FACILITIES AUTHORITY**

**1:00 PM**

**Roscoe J. Hatfield  
Council Chambers  
300 West Evergreen  
Durant, Oklahoma**

**October 11, 2024**

**AMENDED  
SPECIAL CALLED AGENDA**

**CALL TO ORDER**

**ROLL CALL**

**ORDER OF BUSINESS**

**1. Administration**

- a. Financial Update
- b. Discussion, Consideration and Possible Action to Approve Play and Park Structures (Sourcewell Number 111 PC) to Install Shade Structures for Fields 6 and 7 Softball Field Stands at the Durant Multisport Complex up to \$116,321
- c. Discussion, Consideration and Possible Approval of Purchasing Scoreboards for Durant Multi Sports Complex Fields 2,3, 6,7 and 9 for \$76,000
- d. Discussion, Consideration and Possible Approval of Purchasing a Mini Excavator from United Ag (Sourcewell Member 17635) for \$37,850
- e. Discussion, Consideration, and Possible Action to Approve Purchasing New Mini-Split Air Conditioning Units for Baseball and Football Concession Stands for \$6500
- f. Discussion, Consideration, and Possible Action to Approve Purchasing New and Additional Soccer Goals, Nets, and Transportation Kits for the Durant Multi Sports Complex Multi- Purpose Fields for \$50,000
- g. Discussion, Consideration, and Possible Action to Approve the Purchase of 4 Sets of 5 Row, 80 Seat Portable Bleachers and 1 Transport Kit for \$50,000
- h. Discussion, Consideration and Possible Action to Approve Awarding \$20,000 for Renovations to the Durant Multi Sports Complex Press Boxes

- i. Southeastern Oklahoma State University Requests \$163,877.00 for the Construction of Fencing at Paul Laird Field and Adjoining Tailgate Alley
- j. Southeastern Oklahoma State University Requests Any Remaining Funds Available to Supplement the Cost of Replacement of Synthetic Turf on Paul Laird Field

**ADJOURNMENT**

**CERTIFICATE**

This is to certify that in conformity with the Oklahoma Open Meeting Act, public notice of the date, time and place of this meeting was filed with the City Clerk of Durant on the 13th day of September 2024 and that an agenda of said meeting was posted at the place of such meeting at 11:50 a.m. on the 8th day of October 2024. An amended agenda was posted at the place of such meeting at 9:40 a.m. on the 9th day of October 2024.



---

Cynthia J. Price, City of Durant



# The City of Durant

## Memorandum

**Date:** 10/11/2024  
**To:** Mayor and City Council  
**From:**  
**Re:** Administration

---

**Council Information / Action Requested**

**City Staff Information / Action Follow-up, if Council authorizes this action:**

**ATTACHMENTS:**



# The City of Durant

## Memorandum

**Date:** 10/11/2024  
**To:** Mayor and City Council  
**From:** An chen Lai, Finance Director/Treasurer  
**Re:** Financial Update

---

### **Council Information / Action Requested**

Information only.

**City Staff Information / Action Follow-up, if Council authorizes this action:**

**ATTACHMENTS:**



# The City of Durant

## Memorandum

**Date:** 10/11/2024  
**To:** Mayor and City Council  
**From:** Ryan Brewer, Parks and Recreation Manager  
**Re:** Discussion, Consideration and Possible Action to Approve Play and Park Structures (Sourcewell Number 111 PC) to Install Shade Structures for Fields 6 and 7 Softball Field Stands at the Durant Multisport Complex up to \$116,321

---

### **Council Information / Action Requested**

Approve Play and Park Structures (Sourcewell Number 111 PC) to Install Shade Structures for Fields 6 and 7 Softball Field Stands at the Durant Multisport Complex up to \$116,321.00

### **City Staff Information / Action Follow-up, if Council authorizes this action:**

#### **ATTACHMENTS:**

1. Softball shade structures



Play & Park Structures of Okla.  
 PO Box 381  
 Choctaw, OK, 73020  
 Phone: 405-394-0275  
 Fax:  
 Email:  
 heather.harp@playandpark.com  
 Contact: Heather Harp

DURANT MULTI-SPORTS COMPLEX SRP

City of Durant  
 Attn: Ryan Brewer  
 300 W Evergreen  
 Durant, OK 74701  
 Phone: 580-579-6641  
 rbrewer@durant.org

Quote Number: 818-171321  
 Quote Date: 9/17/2024

Stock ID	Description	Quantity	Weight	Unit Price	Amount
CSTM	Wrap Around Uneven Multi-Dome Hanging Cantilever Shade: 111' Length x 12' Width x 10' Entry Height - (5) Domes as per drawing. (7) Columns on Base Plates 6" surfacing at 8"x6". Beams at 6"x4". Rafters at Ø2.875" 12-Ga Without Glide Elbows.	1	0	\$32,352.00	\$32,352.00
CSTM	Wrap Around Uneven Multi-Dome Hanging Cantilever Shade: 115' Length x 12' Width x 10' Entry Height. - 5) Domes as per drawing. (7) Columns on Base Plates 6" surfacing at 8"x6". Beams at 6"x4". Rafters at Ø2.875" 12-Ga Without Glide Elbows	1	0	\$34,033.00	\$34,033.00
DWGS	Engineering: Sealed Drawings & Fees -	1	0	\$2,200.00	\$2,200.00
INSTALL	INSTALLATION OF SHADE STRUCTURES	1	0	\$72,000.00	\$72,000.00
			Total Weight:	0	
				SubTotal:	\$140,585.00
				Freight:	\$6,927.00
				Total Amount:	\$147,512.00

THIS QUOTATION IS SUBJECT TO POLICIES IN THE CURRENT PLAY & PARK STRUCTURES CATALOG AND THE FOLLOWING TERMS AND CONDITIONS. OUR QUOTATION IS BASED ON SHIPMENT OF ALL ITEMS AT ONE TIME TO A SINGLE DESTINATION, UNLESS NOTED, AND CHANGES ARE SUBJECT TO PRICE ADJUSTMENT. PURCHASES IN EXCESS OF \$1,000.00 TO BE SUPPORTED BY YOUR WRITTEN PURCHASE ORDER MADE OUT TO PLAY & PARK STRUCTURES, C/O Play & Park Structures of Okla..

Pricing: f.o.b. factory, firm for 30 days from date of quotation.

Shipment: order shall ship within 45-60 days after Play & Park Structures' receipt and acceptance of your purchase order, color selections, approved submittals, and receipt of deposit, if required.

Freight charges: Prepaid & added

Installation: A certified Play & Park Structures Installer is recommended for play equipment installation. Customer shall be responsible for scheduling coordination and site preparation. Site should be level and permit installation equipment access. Purchaser shall be responsible for unknown conditions such as buried utilities, tree stumps, bedrock or any concealed materials or conditions that may result in additional labor or material costs.

Submittals: our design proposal reflects the spirit and intent of the project plans and specifications. While some variations may exist between our quotation and the project design, the differences do not materially affect the intended use. Play & Park Structures designs and specifications are unique and not intended to be identical in all respects to other manufacturers. We shall submit for review and approval by the owner's representative detailed drawings depicting the equipment to be furnished accompanied by specifications describing materials. Once approved, these drawings and specifications shall constitute the final documents for the project and shall take precedence over all other requirements.

Exclusions: unless specifically included, this quotation excludes all site work and landscaping; removal of existing equipment; acceptance of equipment and off-loading; storage of goods prior to installation; equipment assembly and installation; safety surfacing; borders and drainage provisions.

Acceptance of quotation:

Accepted By (printed): \_\_\_\_\_

Signature: \_\_\_\_\_

Title: \_\_\_\_\_

Purchase Amount: \_\_\_\_\_ \$147,512.00

P.O. No: \_\_\_\_\_

Date: \_\_\_\_\_

Phone: \_\_\_\_\_

E-mail: \_\_\_\_\_

Order Information

Bill to:

Company: \_\_\_\_\_

Attn: \_\_\_\_\_

Address: \_\_\_\_\_

City/State/Zip: \_\_\_\_\_

Billing Contact: \_\_\_\_\_

Billing Phone: \_\_\_\_\_

Billing Fax: \_\_\_\_\_

Ship to:

Company: \_\_\_\_\_

Attn: \_\_\_\_\_

Address: \_\_\_\_\_

City/State/Zip: \_\_\_\_\_

Jobsite Contact: \_\_\_\_\_

Jobsite Phone: \_\_\_\_\_

Jobsite Fax: \_\_\_\_\_

Enter desired color palette name: \_\_\_\_\_

OR

Enter desired color: Uprights ( \_\_\_\_\_ )

Decks ( \_\_\_\_\_ )

Accents ( \_\_\_\_\_ ) Roofs/Tubes ( \_\_\_\_\_ )

Slides/Panels ( \_\_\_\_\_ )

Play & Park Structures of Okla.

By: \_\_\_\_\_

Salesperson's signature

\_\_\_\_\_  
Salespersons's Signature

\_\_\_\_\_  
Customer's Signature



# The City of Durant

## Memorandum

**Date:** 10/11/2024  
**To:** Mayor and City Council  
**From:** Ryan Brewer, Parks and Recreation Manager  
**Re:** Discussion, Consideration and Possible Approval of Purchasing Scoreboards for Durant Multi Sports Complex Fields 2,3, 6,7 and 9 for \$76,000

---

### **Council Information / Action Requested**

Approval of Purchasing Scoreboards for Durant Multi Sports Complex Fields 2,3, 6,7 and 9 for \$76,000

### **City Staff Information / Action Follow-up, if Council authorizes this action:**

#### **ATTACHMENTS:**

1. Scoreboards Quote



# QUOTATION

106 Max Hurt Drive  
Murray KY 42071

Toll-Free: 1-800-323-7745  
[varsityscoreboards.com](http://varsityscoreboards.com)

**BILL TO:**

Ryan Brewer  
rbrewer@durant.org  
580-579-6641  
City of Durant - OK  
Durant, OK 74701

**SHIP TO:**

|  
|  
|

**DETAILS**

Quote Number: 155032322  
Prepared By: Tassie Gossum  
PO Number:  
Created On: August 22, 2024

PART #	DESCRIPTION	QTY.	LIST PRICE (\$)	EXTENDED PRICE (\$)
	<b>15' x 6.5' BASEBALL SCOREBOARD</b>			
3316-22	<ul style="list-style-type: none"> <li>15" LED digits with Protective Shields</li> <li>7 Inning Scoreboard</li> <li>Galvanized steel cabinet with powder coat finish</li> <li>Wireless remote control</li> <li>5 - Year Limited Warranty</li> </ul>	4	\$8,670.00	\$34,680.00
SP15X21-OD	15' School Identification / Sponsor Panel for Outdoor Scoreboards	4	\$660.00	\$2,640.00
	<b>20' x 8' FOOTBALL SCOREBOARD</b>			
7420-22	<ul style="list-style-type: none"> <li>26", 20" and 15" LED digits with Protective Shields</li> <li>Home/Guest Score, To Go, and Ball On up to 99</li> <li>Clock counts down from 99:59</li> <li>Galvanized steel cabinet with powder coat finish</li> <li>Outdoor Horn</li> <li>Wireless remote control with high gain antenna</li> <li>5 - Year Limited Warranty</li> </ul>	1	\$10,968.00	\$10,968.00
SP20X31-OD	20' School Identification / Sponsor Panel for Outdoor Scoreboards	1	\$870.00	\$870.00
CS5	Controller Carrying Case - Large 19" x 16" x 7" Impact Resistant Water Proof Dust Proof	5	\$135.00	\$675.00
INSTALL	INSTALLATION SERVICES	1	\$23,140.00	\$23,140.00

**Subtotal: \$72,973.00**  
**SHIPPING AND HANDLING (TRUCKLOAD): \$2,345.00**

**NOTES**

ADDITIONAL OPTIONS: WIRELESS REMOTE BATTERY POWER \$95 EACH

Quote valid for 30 days. Installation and electrical work not included. Visa, Mastercard, American Express, personal checks, and ACH Check Forms accepted for your convenience.

Please review these graphics carefully. Changes requested after acceptance of this quote may result in additional charges. Colors are for proofing only and may vary on different printers, monitors, and finished products.

MODEL - 3316

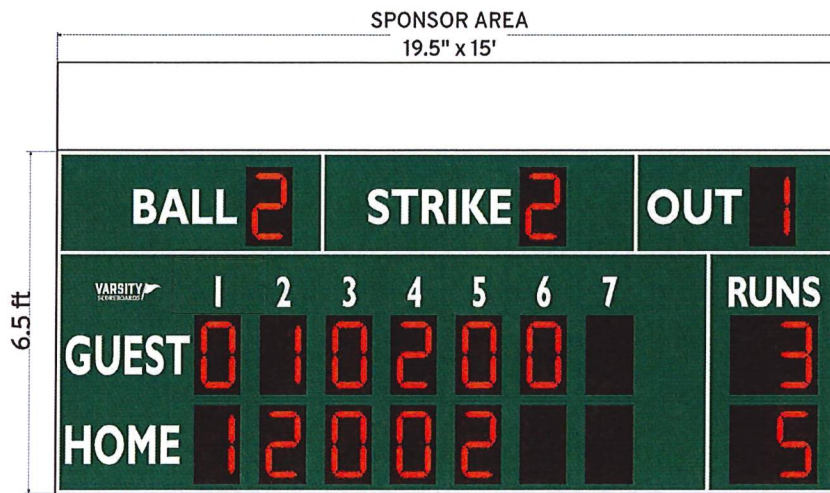

MODEL - 7420-22

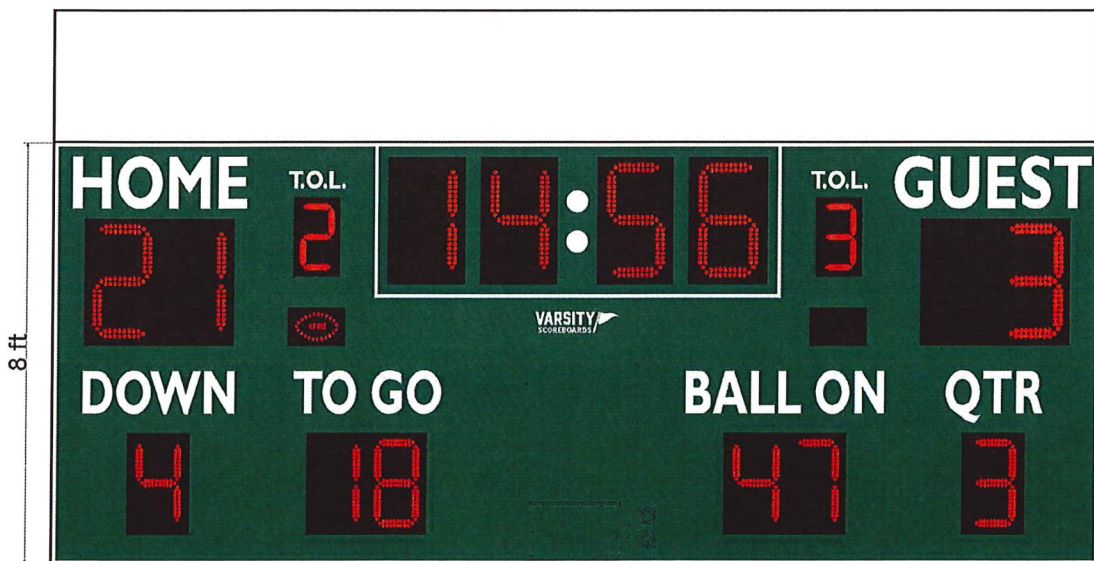

Logo creation fee may apply. If you have any questions concerning this quotation or if there is anything else I can do for you, please give me a call. Thank you for the opportunity to quote on your project.

Sincerely,

**TASSIE GOSSUM**, Sales Associate

[tassie.gossum@varsityscoreboards.com](mailto:tassie.gossum@varsityscoreboards.com)

TEL: 800.323.7745x127





# The City of Durant

## Memorandum

**Date:** 10/11/2024  
**To:** Mayor and City Council  
**From:** Ryan Brewer, Parks and Recreation Manager  
**Re:** Discussion, Consideration and Possible Approval of Purchasing a Mini Excavator from United Ag (Sourcewell Member 17635) for \$37,850.

---

### **Council Information / Action Requested**

Approval of Purchasing a Mini Excavator from United Ag (Sourcewell Member 17635) for \$37,850.

### **City Staff Information / Action Follow-up, if Council authorizes this action:**

#### **ATTACHMENTS:**

1. Mini Excavator Quote

**Quote Summary**

**Prepared For:**  
 CITY OF DURANT PARK DEPARTMENT  
 1920 S HIGHWAY 78  
 DURANT, OK 74701  
 Business: 580-579-6641  
 RBREWER@DURANT.ORG

**Prepared By:**  
 Timmy Newton  
 United Ag & Turf  
 3610 North 1st Avenue  
 Durant, OK 74701  
 Phone: 580-924-4698  
 timmynewton@unitedagt.com

**Quote Id:** 31649465  
**Created On:** 10 September 2024  
**Last Modified On:** 10 September 2024  
**Expiration Date:** 17 September 2024

<b>Equipment Summary</b>	<b>Selling Price</b>	<b>Qty</b>	<b>=</b>	<b>Extended</b>
JOHN DEERE 17G Compact Excavator	\$ 37,850.00	X 1	=	\$ 37,850.00
<b>Equipment Total</b>				<b>\$ 37,850.00</b>

**Quote Summary**

Equipment Total	\$ 37,850.00
SubTotal	\$ 37,850.00
Est. Service Agreement Tax	\$ 0.00
<b>Total</b>	<b>\$ 37,850.00</b>
Down Payment	(0.00)
Rental Applied	(0.00)
<b>Balance Due</b>	<b>\$ 37,850.00</b>

Salesperson : X \_\_\_\_\_

Accepted By : X \_\_\_\_\_



**JOHN DEERE**

# Selling Equipment



Quote Id: 31649465

Customer: CITY OF DURANT PARK DEPARTMENT

## JOHN DEERE 17G Compact Excavator

Hours:

Stock Number:

Code	Description	Qty
0010FF	17G Compact Excavator	1
<b>Dealer Attachments</b>		
	Pick a Bucket	1
	Pick a Bucket	1
	60 month/ 3000 hr PT+H	1
<b>Other Charges</b>		
	Freight	1
	Setup	1



# The City of Durant

## Memorandum

**Date:** 10/11/2024  
**To:** Mayor and City Council  
**From:** Ryan Brewer, Parks and Recreation Manager  
**Re:** Discussion, Consideration, and Possible Action to Approve Purchasing New Mini-Split Air Conditioning Units for Baseball and Football Concession Stands for \$6500.

---

### **Council Information / Action Requested**

Approve Purchasing New Mini-Split Air Conditioning Units for Baseball and Football Concession Stands for \$6500.

### **City Staff Information / Action Follow-up, if Council authorizes this action:**

#### **ATTACHMENTS:**

1. Minisplit AC unit quote



4019 W. Hwy. 70, #311  
Durant, OK 74701

### Estimate

Date	Estimate #
7/1/2024	4127

<b>Bill To</b>
Mark Pierce P. O. Box 578 Durant, OK 74702-0578

Phone #

5809249973
------------

E-mail

TMR74701@GMAIL.COM
--------------------

*PO # 2589295*

Description	Qty	Rate	Amount
Change Out 1.5 ton Mini Split unit at the softball field (Sports Complex) 1- 1.5 Ton 18- Seer Samsung outdoor unit 1- Indoor Wall mounted air handler Wireless controller Vacuum system down and set the factory charge. Labor to install the above Factory Warranty		3,250.00	3,250.00
<i>Quote</i>		<i>Becky called Shelia on 7/29/24 to get scheduled</i>	
Sales tax included. Estimate good for 30 days. Any changes must be in writing.		<b>Total</b>	<b>\$3,250.00</b>

**Ask Us About Financing...**



# The City of Durant

## Memorandum

**Date:** 10/11/2024  
**To:** Mayor and City Council  
**From:** Ryan Brewer, Parks and Recreation Manager  
**Re:** Discussion, Consideration, and Possible Action to Approve Purchasing New and Additional Soccer Goals, Nets, and Transportation Kits for the Durant Multi Sports Complex Multi- Purpose Fields for \$50,000.

---

### **Council Information / Action Requested**

Approve Purchasing New and Additional Soccer Goals, Nets, and Transportation Kits for the Durant Multi Sports Complex Multi- Purpose Fields for \$50,000.

### **City Staff Information / Action Follow-up, if Council authorizes this action:**

#### **ATTACHMENTS:**

1. Soccer goals and net quote

Level up your fans in top brands & products with a custom Fanwear Shop.



## MY CART (20)

Have questions about your order? Call [1-800-856-3488](tel:1-800-856-3488) for assistance or visit our [Help Center](#).



**KWIK GOAL**

KwikGoal Pro Premier European Match Goal

**UNIT PRICE: \$9,299.99**

SKU: 64885\_1291162

**QUANTITY**

1

**Subtotal: \$9,299.99**

Ships Truck

Edit



**KWIK GOAL**

KwikGoal Deluxe European Club Goal 4 x 6

**UNIT PRICE: \$3,899.99**

## ORDER SUMMARY



[Proceed To Checkout](#)

Ships Truck

[Edit](#) 

**KWIK GOAL**



KwikGoal Deluxe European Club Goal 7 x 21

**UNIT PRICE: \$5,899.99**

**QUANTITY**

SKU: 64877\_1291087

1 

**Subtotal: \$5,899.99**

Ships Truck

[Edit](#) 

**KWIK GOAL**



KwikGoal Deluxe European Club Goal 6.5 x 18.5

**UNIT PRICE: \$5,799.99**

**QUANTITY**

SKU: 64878\_1291094

2 

**Subtotal: \$11,599.98**

Ships Truck

[Edit](#) 

UNIT PRICE: \$299.99

QUANTITY

SKU: 78369\_1367767

2 

Subtotal: \$599.98

Ships FedEx

[Edit](#) 

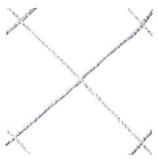

ALUMAGOAL

Recreational Soccer Net - 8'H x 24'W x 5'D x 10'B

UNIT PRICE: \$199.99

QUANTITY

SKU: 53975\_SN383ECOW

1 

Subtotal: \$199.99

Ships FedEx

[Edit](#) 



BSN SPORTS

Club Soccer Net 4.0 mm 7Hx21Wx3Dx7.5B

UNIT PRICE: \$319.99

QUANTITY

SKU: 78368\_1367768

1 

[Edit](#) 

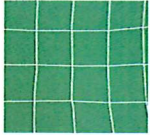

**BSN SPORTS**

Club Soccer Net 3.0 mm 4Hx6Wx2Dx4B

**UNIT PRICE: \$199.99**

**QUANTITY**

SKU: 78372\_1367771

6 

**Subtotal: \$1,199.94**

Ships FedEx

[Edit](#) 

**All Things BSN SPORTS. Straight to Your Inbox.**

Sign up now to receive the latest BSN SPORTS news, discounts and benefits.

rbrewer@durant.org

**Join Us**

SERVICES

OUR COMPANY



# The City of Durant

## Memorandum

**Date:** 10/11/2024  
**To:** Mayor and City Council  
**From:** Ryan Brewer, Parks and Recreation Manager  
**Re:** Discussion, Consideration, and Possible Action to Approve the Purchase of 4 Sets of 5 Row, 80 Seat Portable Bleachers and 1 Transport Kit for \$50,000.

---

### **Council Information / Action Requested**

Approve the Purchase of 4 Sets of 5 Row, 80 Seat Portable Bleachers and 1 Transport Kit for \$50,000.

### **City Staff Information / Action Follow-up, if Council authorizes this action:**

#### **ATTACHMENTS:**

1. Portable Bleachers quote



PO Box 841393  
 Dallas, TX 75284-1393  
 Phone: 800-527-7510 Fax: 800-899-0149  
 Visit us at www.bsnsports.com

Quote
Cart #: 21447319
Purchase Order #: Ryan - bleachers
Cart Name: ryan - bleachers
Quote Date: 03/23/2023
Quote Valid-to: 04/27/2023
Payment Terms: NT00
Shlp Via:
Ordered By: Ryan Brewer

Contact Your Rep  
 Ryan Leininger Email: rleininger@bsnsports.com | Phone: 972-884-7261

**Sold to**  
 1099953  
 DURANT YOUTH SPORTS  
 324 N 1ST AVE  
 DURANT OK 74701-4208  
 USA

**Ship To**  
 1099953  
 DURANT YOUTH SPORTS  
 324 N 1ST AVE  
 DURANT OK 74701-4208  
 USA

**Payer**  
 1099953  
 DURANT YOUTH SPORTS  
 324 N 1ST AVE  
 DURANT OK 74701-4208  
 USA

Item Description	Qty	Unit Price	Total
<b>5 Row 80 Seat Transp Preferred Bleach</b> Item # - NBT0524P	4 EA	\$ 10,000.00	\$ 40,000.00
<b>Transport Kit for 5 Row Transp Bleacher</b> Item # - NBTk5	2 EA	\$ 2,000.00	\$ 4,000.00

Subtotal:	\$44,000.00
Other:	\$0.00
Freight:	\$2,145.00
Sales Tax:	\$4,326.09
Order Total:	\$50,471.09
Payment/Credit Applied:	\$0.00
<b>Order Total:</b>	<b>\$50,471.09</b>



# The City of Durant

## Memorandum

**Date:** 10/11/2024  
**To:** Mayor and City Council  
**From:** Ryan Brewer, Parks and Recreation Manager  
**Re:** Discussion, Consideration and Possible Action to Approve Awarding \$20,000 for Renovations to the Durant Multi Sports Complex Press Boxes.

---

### **Council Information / Action Requested**

Approve Awarding \$20,000 for Renovations to the Durant Multi Sports Complex Press Boxes.

### **City Staff Information / Action Follow-up, if Council authorizes this action:**

#### **ATTACHMENTS:**

1. press box quotes

The goal is to make every field have its own press box to control the scoreboard and have the capabilities to have a PA system or music playing during games. Right now, we have 3 fields that have this capability but even then the system does not work anymore or is not reliable. If we improve each of the fields to have the same system to provide those who are at the game some enjoyment with walk out songs, or just music to play during large events. Preferably, we go big and provide video streaming services for each field so those who cannot attend live can experience it virtually. The streaming services varies depending on how big we want to go anywhere from \$2000-\$4000 or more per field.

Fields 2,3,4,6,7,8 will need to be enclosed and insulated, an ac unit, door and windows, the PA system and if we want to a Streaming system.

Item	Price per stand	Total Price
AC unit	\$600	\$3600
Audio/PA System	\$2000	\$12000
Sheet Metal and Insulation	\$5,000	\$30,000
Doors and Windows	\$1500	\$9,000
Optional Video streaming	\$4000	\$24,000
Total price w/o streaming	\$9,100	\$54,000
Total Price w/ Streaming	\$13,000	\$78,000

Fields 1, 5 and 9 will need less work just replacing the old PA system and speakers a new AC unit and if we want a streaming system. Total price per stand

Item	Price per stand	Total Price
AC unit	\$600	\$3600
Audio/PA System	\$2000	\$12000
Optional Video streaming	\$4000	\$24,000
Total price w/o streaming	\$7,800	\$23,000
Total Price w/ Streaming	\$11,800	\$35,000

W/o Streaming total \$77,000

W/ Streaming \$113,000 ~~78~~ Max



Electronics

New Arrivals Deals Cell Phones Computers TV & Video Headphones Office Electronics

Back to results



### Outdoor PA Sound Public Address Speaker System KIT for Baseball Football Fields w/ 4 Weatherproof Speakers

Brand: AcousticBay

1.0 1 rating | Search this page

\$1,779<sup>00</sup>

Pay \$148.25/month for 12 months, interest-free upon approval for Amazon Visa

#### Delivery & Support

Select to learn more

Ships from AcousticBay	30-day easy returns	Customer Support

Roll over image to zoom in

Brand	AcousticBay
Connectivity Technology	AUX
Mounting Type	Wall Mount
Power Source	Corded Electric
Connector Type	Aux

#### About this item

- 1 x Commercial Mixer / Amplifier 4 mic & 2 Aux inputs, 120 Watt @ 70V Audio Output.
- 4 x Two-Way Rectangular Weatherproof Speakers (8" Woofer and 1" Tweeter) speakers come with mounting brackets.
- 1 x 500 ft. Spool of High-Quality Speaker Wire
- 1 x Wireless Microphone and 1 X Standard Wired Microphone with Cable - MUSIC Patch in Cable included also.

Report an issue with this product or seller

\$1,779<sup>00</sup>

\$87.30 delivery Tu  
September 17. De

Delivering to Dur  
Update location

Only 3 left in stock soon.

Quantity: 1

Add to Cart

Buy Now

Ships from AcousticBay  
Sold by AcousticBay  
Returns 30-day refund/replacement  
Payment Secure transaction

#### Add a Protection Plan

- 2 Year Portable Accident Protection \$119.99
- 3 Year Portable Accident Protection \$159.99
- Asurion Complete One plan covers past and future (Renews Monthly, Canceled) for \$16.99/month

Add to List

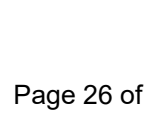

Notifications

lv

What are you looking for today?

Durant Lowe's   
 Open until 9 PM



Prices, Promotions, styles, and availability may vary. Our local stores do not honor online pricing. Prices and availability are subject to change without notice. Errors will be corrected where discovered, and Lowe's reserves the right to correct any errors, inaccuracies or omissions including after an order has been submitted.

[Back to Results](#) / [Windows & Doors](#) / [Windows](#) / [Sliding Windows](#)

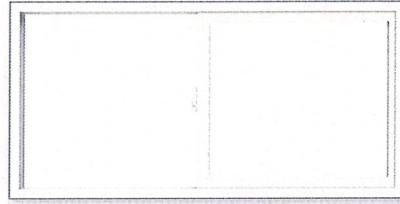
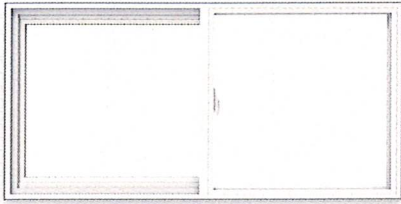

JELD-WEN V-2500 47-1/2-in x 23-1/2-in x 2-29/32-in Jamb White Sliding Window Full Screen Included  
Item #358333 | Model #LOWOLJW232900568

12

**\$243.72**

\$231.53 When you choose 5% savings on eligible purchases

Buy Now, Pay Later  
\$22.00 with 12 monthly payments. [Learn How](#)

—  +

[Get It Installed](#)

**Pickup**  
Ready by **Mon, Oct 7 (Est.)**

**Delivery**  
As soon as possible

FREE Pickup at Durant Lowe's

Please contact local store to order with FBC/TDI ce

Join. Earn. Save. [Learn More](#)  
Earn points on eligible purchases towards MyLowe's Money

JELD-WEN V-2500 47-1/2-in x 23-1/2-in x 2-29/32-in Jamb Left-operable Vinyl White Sliding Window Full Screen Included

12

**\$243.72**

[Learn More](#)

in-store or ship it to you

BETTER TOGETHER

CURRENT ITEM

Selected

Selected

Help

Notifications

lv

What are you looking for today?

Durant Lowe's   
 Open until 9 PM



Prices, Promotions, styles, and availability may vary. Our local stores do not honor online pricing. Prices and availability are subject to change without notice. Errors will be corrected where discovered, and Lowe's reserves the right to correct any errors, inaccuracies or omissions including after an order has been submitted.

[Back to Results](#) / [Heating & Cooling](#) / [Air Conditioners & Fans](#) / [Room Air Conditioners](#) / [Wall Air Conditioners](#)

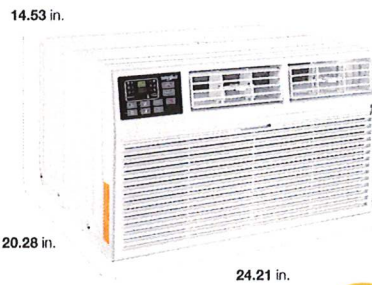
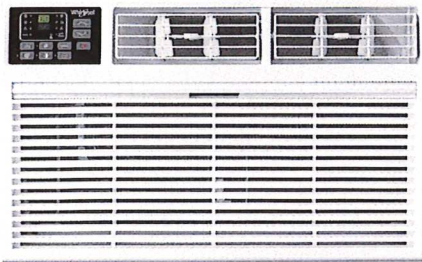

In 30+ carts last week

Whirlpool 8000-BTU 350-sq ft 115-Volt White Through Heater Included with Remote

Item #6288446 | Model #WHAT082-HAW

21

**\$529.99**

**\$503.49** When you choose 5% savings on eligible purchases every day. [Learn How](#) **OR** **\$89.** with [Lea](#)

Buy Now, Pay Later **\$47.84** with 12 monthly payments. [Learn How](#)

Cooling BTU Rating (BTU): 8000

8000  10000  12000  14000

Heater Included: Yes

Yes  No

—  +

**Pickup**   
 Ready by **Sat, Sep 14**

**Delivery**   
 As soon as **Fri**

FREE Pickup at Durant Lowe's

[View All Images](#)

Whirlpool 8000-BTU 350-sq ft 115-Volt White Through-the-wall Air Conditioner Heater Included with Remote **\$529.99**

21

Join. Earn. Save. [Learn More](#)   
 > purchases towards MyLowe's Money

[Help](#)

Notifications

lv

What are you looking for today?

**Durant Lowe's**   
 Open until 9 PM



Prices, Promotions, styles, and availability may vary. Our local stores do not honor online pricing. Prices and availability are subject to change without notice. Errors will be corrected where discovered, and Lowe's reserves the right to correct any errors, inaccuracies or omissions including after an order has been submitted.

< [Back to Results](#) / [Windows & Doors](#) / [Exterior Doors](#) / [Front Doors](#)

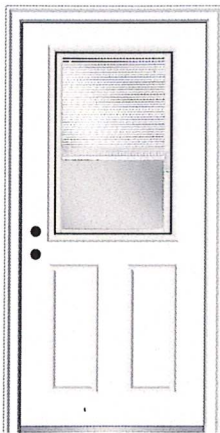
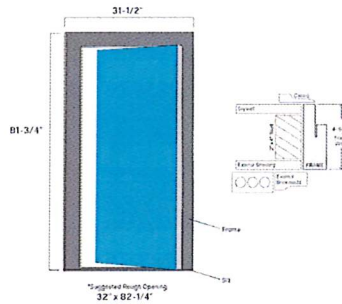

Illustration depicts prehung unit dimension.  
Width - Measured end to end of frame.  
Height - Measured bottom of sill to top of frame.  
Depth - Frame Width.



200+ views last week

MMI DOOR 30-in x 80-in x 4-9/16-in Fiberglass Half Lite Primed Prehung Front Door with Brickmould Insulation  
Item #2412458 | Model #ZZ365430R

★★★★☆ 23

**\$1,073.88** | ~~\$1,248.00~~   
 Save \$174.12



\$1020.19 When you choose 5% savings on eligible purchases every day. [Learn How](#)

OR

\$175 with [Lea](#)

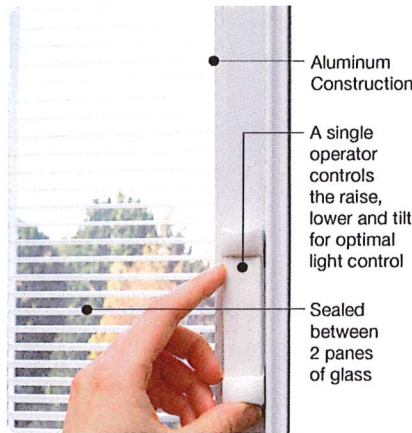
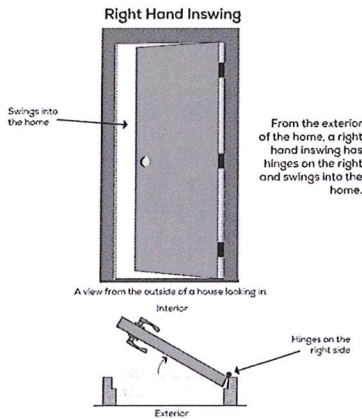

**Lowes Pay** Buy Now, Pay Later  
\$66.99 with 18 monthly payments. [Learn How](#)

1 +  [Add to](#)

- Let Us Install Your Door**
- Schedule a FREE in-home consultation
  - Get help choosing your door
  - Get quote for product, install and financing

Feedback

[View All Images](#)

[Get It Installed](#)

MMI DOOR 30-in x 80-in x 4-9/16-in Fiberglass Half Lite Right-Hand Inswing Primed Prehung Front Door with Brickmould Insulating Core with Blinds

★★★★☆ 23

**\$1,073.88**

Jamb Width: 4-9/16-in



Blinds



Lockset Bore: Double



Adjustable Sill

FREE Pickup at Durant Lowe's

Key Features

Easy & Free Returns

[Help](#)



# The City of Durant

## Memorandum

**Date:** 10/11/2024  
**To:** Mayor and City Council  
**From:** Mark Webb, Authority Board Member  
**Re:** Southeastern Oklahoma State University Requests \$163,877.00 for the Construction of Fencing at Paul Laird Field and Adjoining Tailgate Alley

---

### Council Information / Action Requested

City Staff Information / Action Follow-up, if Council authorizes this action:

### ATTACHMENTS:

1. Texoma Manufacturing Estimate



PO Box 1940  
 Durant, OK 74702  
 580.920.0878  
 scott.crain@texomamfg.com

# Estimate

Date	Estimate #
7/25/2024	2364

Name / Address
Southeastern Ok. State University Purchasing Office PO Box 4240 Durant, OK 74701

Ship To

P.O. No.	Terms	Due Date	Rep	PROJECT
	Due on receipt	7/25/2024	JSC	

Item	Description	Qty	Price	Total
01	Fab and Install Approx 1340' 6' Fence Railing 3" Posts, 3/4" Pickets, 1 1/2" Triple Horizontal Rails	1	104,777.00	104,777.00
01	Walk Through Gate	2	1,250.00	2,500.00
01	Double Drive Through Gate	1	2,600.00	2,600.00
01	Brick Columns	12	4,500.00	54,000.00

Thank you for your business!

<b>Total</b>	\$163,877.00
<b>Sales Tax (0.0%)</b>	\$0.00



# The City of Durant

## Memorandum

**Date:** 10/11/2024  
**To:** Mayor and City Council  
**From:** Mark Webb, Authority Board Member  
**Re:** Southeastern Oklahoma State University Requests Any Remaining Funds Available to Supplement the Cost of Replacement of Synthetic Turf on Paul Laird Field.

---

The total cost of the project is \$708,855.00.

### **Council Information / Action Requested**

**City Staff Information / Action Follow-up, if Council authorizes this action:**

### **ATTACHMENTS:**

1. 3P - Hellas Base Proposal Oklahoma State University 06.10.2024.



June 06, 2024

Keith Baxter  
Director of Athletic  
SEOSU  
(580) 775-2965  
[kbaxter@se.edu](mailto:kbaxter@se.edu)

RE: Oklahoma State University - Synthetic Turf.  
425 W University Blvd, Durant, OK 74701

**Hellas** is pleased to provide you with this proposal. Pricing is based on Hellas' current cooperative contract entitled Purchase via Sourcwell Contract 031622-HLC - Artificial Turf and Tracks with Installation, Related Equipment, Materials and Supplies. Through this contract, Hellas' products have been competitively and lawfully bid to provide member schools and agencies with quality and preferential pre-priced products and services.

### **General Conditions**

**Hellas** will:

1. Provide project insurance, supervision, and mobilization.
2. Provide construction surveying, layout, and staking.
3. Provide performance and payment bonds.
4. Provide, prior to construction, all required submittals.
5. Provide, prior to construction, synthetic turf shop drawings.
6. Provide final punch-out and clean-up of the completed project.
7. This proposal assumes a start date of Spring 2024. Pricing to be adjusted if the start date is rescheduled to a later date.

### **BASE PROPOSAL – Synthetic Turf at Oklahoma State University**

#### **Synthetic Turf**

**Hellas** scope of work:

1. **Removal** - Remove existing turf and dispose of it off-site. *Hellas will conduct tests in several locations of the existing aggregate stone base material to determine if the existing base meets permeability requirements. If the tests show that the existing aggregate stone base material does not drain adequately, Hellas will notify the owner and provide an additional scope of work and proposal pricing to correct the identified deficiencies of the existing aggregate and/or existing drainage piping system.*





2. Grading – Regrade existing finish aggregate layer (*no purchase of stone drainage material or grade changes is included in this proposal*).
3. Synthetic Turf - Provide and install approximately 80,625 square feet of **matrix® HELIX 46 oz.** 100% Polyethylene Extruded Monofilament synthetic turf system with the noted installation options listed below.
  - Football lines and markings per attached rendering.
  - End Zone letters and colors per attached rendering.
  - Logos per attached rendering
  - One (1) center logo per attached rendering.
  - Two (2) small logos per attached rendering.
  - Proprietary **REALFILL™** (patent no. 6,800,339 B2) installation of selectively graded aggregate and ambient ground SBR rubber.
  - Provide an 8-year manufacturer warranty.

#### **ALTERNATE 1: Cushdrain Pad**

**Hellas** scope of work:

1. Shock Pad – Install ±80,625 square feet of 19 mm **CUSHDRAIN®** shock pad at the synthetic turf area.

#### **ALTERNATE 2: Wave Pad**

**Hellas** scope of work:

1. Shock Pad – Install ±80,625 square feet of **The Wave®** shock pad at the synthetic turf area.

#### **ALTERNATE 3: Ecotherm**

**Hellas** scope of work:

1. Synthetic Turf - Provide and install approximately 80,625 square feet of **matrix® HELIX 46 oz.** 100% Polyethylene Extruded Monofilament synthetic turf system with **ecotherm™** infill.
2. The **ecotherm™** infill option must be selected with a shock pad.

**After synthetic turf installation is complete, Hellas will provide an operation and maintenance orientation for care of the turf field, and all supplied equipment quoted above.**

**Base Proposal**

**\$454,825.00**

---



<b>ALTERNATE 1</b>	<b>Proposal</b>
Base Proposal	\$454,825.00
Add alternate for 19 mm <b>CUSHDRAIN®</b> Shock Pad	\$254,030.00
<b>Total Proposal</b>	<b>\$708,855.00</b>
<b>ALTERNATE 2</b>	
<b>Proposal</b>	
Base Proposal	\$454,825.00
Add alternate for <i>The Wave</i> pad	\$147,100.00
<b>Total Proposal</b>	<b>\$601,925.00</b>
<b>ALTERNATE 3</b>	
<b>Proposal</b>	
Base Proposal	\$454,825.00
Add alternate for <b>ecotherm™</b> Cooling Infill (No pad included)	\$164,095.00
<b>Total Proposal</b>	<b>\$618,920.00</b>

## **EXCLUSIONS**

1. Any item of work not specifically listed above.
2. Any kind of soil stabilization.
3. Existing aggregate base repairs.
4. Existing drainage system repairs.
5. Existing irrigation system remediation.
6. Nailer replacement.
7. Any concrete work.
8. Poor subgrade soils – Hellas will proof roll subgrade to check for subgrade soil stability. Any failing subgrade remediation will be negotiated between the owner and contractor. **Hellas strongly suggests that the owner contract with a Geotechnical Engineer to perform a Geotechnical investigation of the site to determine the nature of the existing subgrade soils and make recommendations for any subgrade stabilization requirements.**
9. Rock excavation or haul off.
10. Any embankment or processing of imported soils.
11. Any fence works.
12. Engineering.
13. Supply or installation of perimeter safety or construction fencing.
14. Site security.
15. Any allowances or contingencies.
16. Taxes.
17. Prevailing wages.
18. Any permits or fees, including any utility impact fees generated by construction improvements.



19. The owner shall provide ingress/egress for ALL personnel, equipment and materials; typical construction traffic shall be expected for the duration of this contract. Contractor NOT responsible for damage due to typical construction traffic ingress/egress to the construction site.
20. The owner to supply secure laydown area for Hellas materials.

Notwithstanding anything to the contrary in any of the Contract documents, under no circumstances shall the Performance bonds, maintenance bonds or the obligations of the Surety be liable for any warranty obligations that exceed 1 year from the date of substantial completion as defined in the Contract documents.

**Hellas** looks forward to the award of this project, and is eager to work with you.

***\*Pricing valid for 14 days from date of this proposal.***

A handwritten signature in blue ink, appearing to read "Alvaro", with a stylized flourish.

**Alvaro Ontiveros Lizarraga.**

Estimator.

(737) 235-1912

[aontiveros@hellasconstruction.com](mailto:aontiveros@hellasconstruction.com)

Hellas

COLOR RENDERING FOR CONCEPTUAL PURPOSES ONLY

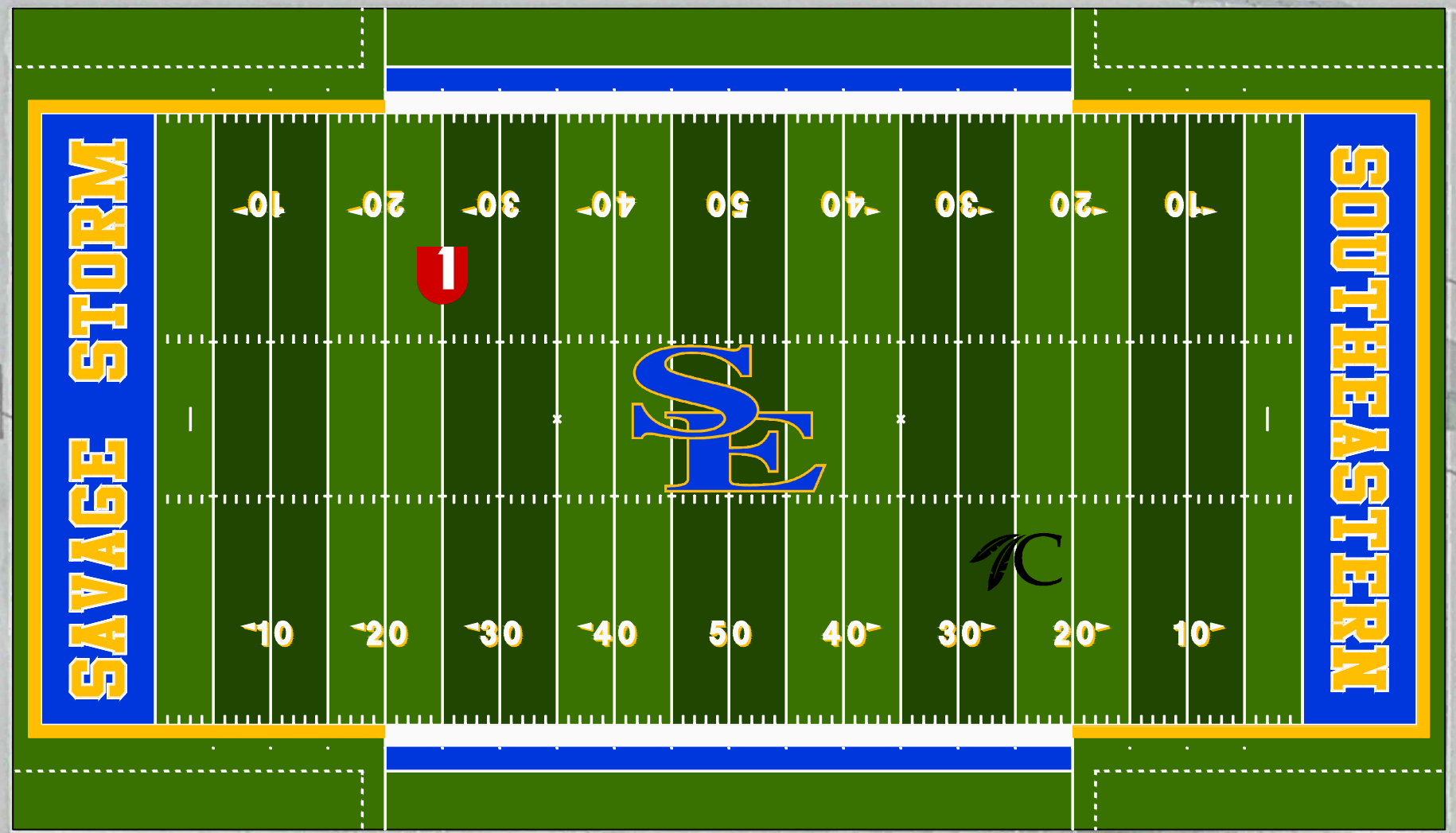

**Hellas**  
 Hellas Construction, Inc. (P) (512) 250-2910  
 12000 West Parmer Lane (F) (512) 250-1960  
 Austin, TX 78613 hellasconstruction.com

**OWNER:**  
 Southeastern Oklahoma State University  
 Paul Laird Field  
 200-298 W University Blvd, Durant, OK. 74701  
 580-745-200

**PROJECT:**  
 SYNTHETIC TURF FOOTBALL FIELD  
 CONSTRUCTION

**PROJECT LOCATION:**  
 DURANT, OKLAHOMA



**COMMENTS:**  
 Drawing scale accurate ONLY when printed on 11x17 paper. For visual purposes only, actual color may vary.

**CREATED BY:** DSR

All drawings and written material appearing herein constitute original unpublished work, and may not be duplicated, used or disclosed without the written consent of Hellas Construction, Inc.

**DATE:**  
 APRIL 11, 2024

**REVISION:**  
 OPT A REV 1

**SHEET TITLE:**  
 COLOR RENDERING

**SHEET NUMBER:**  
 1

